

Set Up Instructions

CA700-CASE TO COUNTER

Step 1: Put case flat on the floor and undo straps. Lift lid and remove the contents of the case.

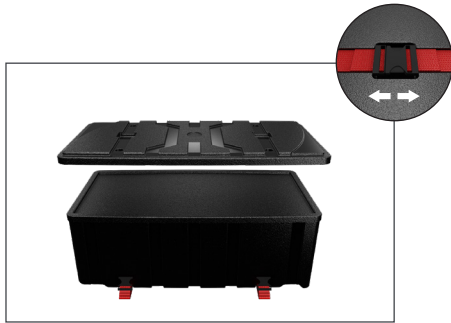

Step 2: Put the lid on the floor and screw the supplied vertical support poles into place.

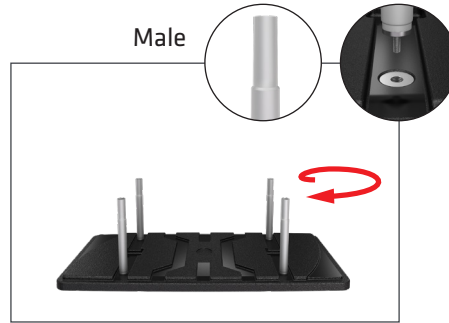

Step 3: Put the base on the floor with wheels up and screw the supplied vertical support poles into place.

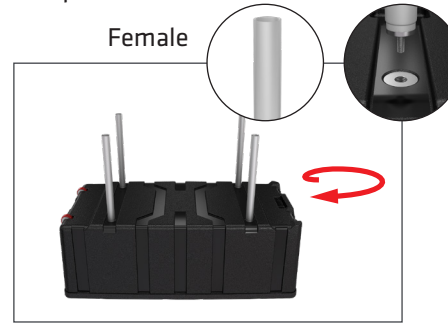

Step 4: Align support poles and fit the base to the lid. Press together firmly to secure.

OPTIONAL: Install storage pocket onto lid first.

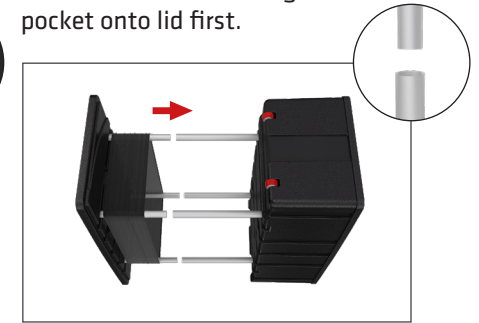

Step 5: Place case in a clean area upside down to stretch fabric print, over the case. **Start at the top with graphic up side down**, make sure zipper is in the middle.



Pull the silicone grooved edge of graphic over the top of the lid and push onto the edge. Push the groove all the way around the case until secured.

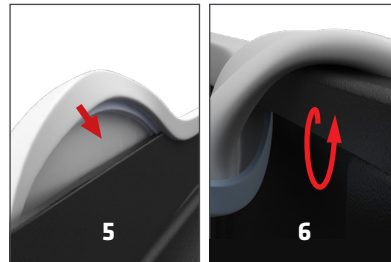

Step 6: Upright the case and pull edge of graphic over the top of the base and tuck under the lip into the groove of case. Follow all the way around the case until secured.



Step 7: Make sure that all wrinkles are out and the fabric looks straight. Press the counter top onto the case to secure.

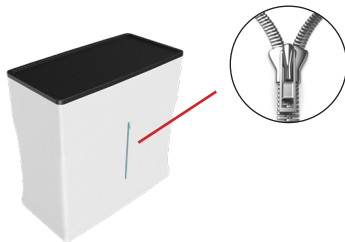
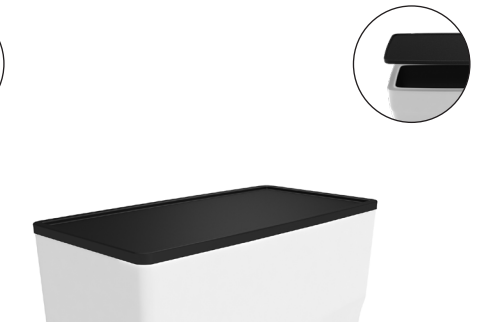

STORAGE:

The zipper on the back is used to access storage.

